

Best Management Practices

Trapping Raccoons in the United States

UPDATED 2021



ASSOCIATION *of*
FISH & WILDLIFE
AGENCIES

Best Management Practices (BMPs) are carefully researched recommendations designed to address animal welfare and increase trappers' efficiency and selectivity. The extensive research and field-testing used to develop BMPs are described in the Introduction section of this manual. The evaluation methods used to develop BMPs have been standardized, enabling BMPs to be easily updated and revised as new traps and techniques become available. All traps listed have been tested and meet performance standards for animal welfare, efficiency, selectivity, practicality and safety.

Trapping BMPs provide options, allowing for discretion and decision making in the field. They do not present a single choice that can or must be applied in all cases. They are meant to be implemented in a voluntary and educational approach. BMPs are the product of ongoing work that may be updated as additional traps are identified through future scientific testing.

The Raccoon at a Glance

Characteristics

The raccoon is a medium-sized mammal with a short, stocky build (Figure RA1). Adults generally range from 9-20 pounds and are smallest in the southeastern United States; a few may reach 40 pounds in the Northern portions of their range. Raccoons are active at night and rest in dens during the day. They are excellent climbers and strong swimmers. Raccoons have a well-developed ability to grasp and manipulate objects with their front paws. Raccoons will den in groups and remain dormant during extreme winter weather, but they do not hibernate. Large deposits of fat accumulated during late summer and fall allow raccoons to survive periods of food scarcity during winter. The scientific name is *Procyon lotor*.

Range

Raccoons occur throughout most of southern Canada and the United States except for the deserts of the southwest and higher elevations of the Rocky Mountains. They range southward into Central America.

Habitat

Raccoons are adaptable and use many habitat types. They prefer hardwood forests with numerous den sites and are usually most abundant around water, especially bottomland hardwood forests along streams, hardwood swamps, and edges of reservoirs, marshes, and ponds. Raccoons are also at home in agricultural landscapes and urban and suburban areas. They prefer hollow trees for dens, but readily use abandoned woodchuck burrows, caves, and artificial structures, such as barns, attics and culverts.

Food Habits

Raccoons are omnivorous. They will eat fish, crayfish and mussels, as well as a variety of fruits, nuts, grains, other plant material, carrion, garbage, birds, eggs, small animals (mice, rabbits, snakes, turtles, frogs and insects) and most foods prepared for human or animal consumption. Raccoons are significant predators of ground-nesting birds.

Reproduction

Breeding season extends from January to June and occurs later in the South than in the North. Most litters are born in April and May, but young can be born as late as September. In the far Southeast (Florida, South Carolina, and Alabama), some young are probably born throughout the year. Cubs are born about 63 days after breeding. Litter size ranges from two to eight and averages four. Weaning starts at about eight weeks, and by four months of age, most cubs are large enough to be on their own. Many family groups stay together through the young's first winter.

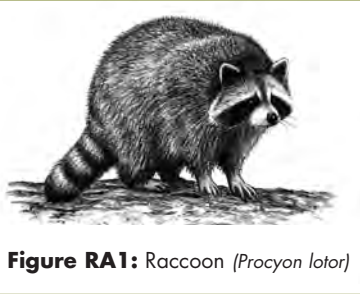

Figure RA1: Raccoon (*Procyon lotor*)

Populations

Raccoons are considered abundant throughout their range. Under ideal conditions, population density may reach one raccoon for every two acres of habitat. Home range size varies with habitat, seasonal food availability, and weather. Home ranges can be as small as 0.02 square miles in some urban settings to over 18.75 square miles in the prairies of North Dakota.

Comments

Raccoons are highly susceptible to canine distemper and rabies, and outbreaks of these diseases can significantly reduce local populations. Raccoons also harbor the raccoon roundworm (*Baylisascaris procyonis*), a nematode that can cause serious illness in humans.

General Overview of Traps Meeting BMP Criteria for Raccoons in the United States

Six basic types of traps were tested for raccoons: jaw-type foothold restraining traps, enclosed foothold restraining traps, bodygrip traps, cage traps, powered cable devices for foot capture, and non-powered cable devices (Table RA2). Examples, descriptions, and mechanical details of the various devices tested that met BMP criteria are in this section.

Table RA2. Overview of traps meeting BMP criteria for raccoon in the United States.

Trap Category	Jaw/Frame Characteristics	Inside Jaw/Frame Spread at Dog*	Inside Width at Jaw/Frame Hinge Posts*
Coil-spring	Unmodified	3 11/16	3 1/2
	Double-jaw	4 5/16 - 4 9/16	4 5/8 - 4 13/16
	Padded-jaw	4 1/2	4 7/16
Longspring	Double-jaw	3 7/8	3 7/16
Enclosed Foothold	Round Bar* (diameter)	Opening Diameter*	Depth of Trigger*
	0.118 - .162	1 1/4 - 1 1/2	2 1/8 - 2 7/8
Cage	Total Dimensions* (length x width x height) 32 x 10 x 12.75	Door Size* 10 x 12	Mesh Size/Gauge* 1x1 - 1x2 12-14 gauge galvanized
	Height of Trap Window* 5 - 8	Width of Trap Window* 4 3/16 - 8 3/16	Frame Wire* 3/16 - 5/16 Spring Wire* 3/16 - 5/16
Powered Cable Device	Smooth round rod, 1/8 inch cable	6 3/8	6
	Cable Characteristics	Loop Diameter	Locks
Non-Powered Cable Device	3/32 or 5/64 inch diameter stranded cable	6	Relaxing locks

* Inches



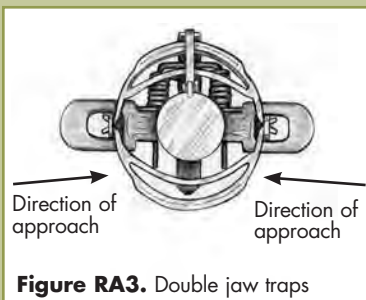

Figure RA3. Double jaw traps

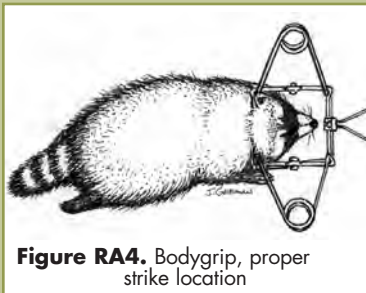

Figure RA4. Bodygrip, proper strike location

General Considerations When Trapping Raccoons

Jaw-Type Traps (Double-Jaw Type and Small Jaw Traps for Raccoons)

- Many currently used trap models can be modified by adding a second “jaw” (i.e. double jaw) below the primary jaw to meet criteria. The primary jaw restrains the foot, and the second “jaw” limits access to the foot when the trap is in the sprung position
- Double-jaw traps should be oriented when set so that an approaching animal will step between the jaws rather than over them (Figure RA3)
- Pan stops limit the range of foot placement in the trap
- Can be used in unbaited blind sets
- Can be used to capture several furbearer species
- Minimizing area between jaw and pan when closed improves animal welfare
- Captures and holds animals alive, allowing for release

Enclosed Foothold Traps

- Requires use of baits
- Highly selective for raccoons and opossums
- Design reduces potential to capture dogs or cats
- Captures and holds animals alive, allowing for release

Cage Traps

- Cumbersome
- Can be used to capture several furbearer species
- Often requires bait
- Captures and holds animals alive, allowing for release

Bodygrip Traps

- Bodygrip trap should be placed so that the rotating jaws close on either side of the captured animals neck (Figure RA4)
- Selectivity features can be enhanced by use of recessed sets (in cubby or cage), restricted openings, or elevated sets
- Trigger configurations can be modified
- Allows for use in locations and in weather conditions where other traps are less effective
- May not be appropriate in some areas (captures and kills animals, no release)

Non-Powered Cable Devices

- The use of loop stops and breakaway devices can improve selectivity
- Cables require frequent replacement
- Captures and holds animals alive, allowing for release

Specifications of Traps Meeting BMP Criteria for Raccoons in the United States

As more capture devices are tested and new information becomes available, they will be added to an updated list. Mechanical descriptions of tested traps are given as an aid to trappers or manufacturers who may wish to measure, build or modify traps to meet these specifications. Also, other commercially available traps, modified traps or other capture devices not yet tested may perform as well as or better than the listed BMP traps. References to trap names are provided to identify the specific traps tested. This list is provided for information purposes only and does not imply an endorsement of any manufacturer.

These are average mechanical measurements which are rounded to the nearest $\frac{1}{16}$ inch. There may be up to a $\frac{1}{8}$ inch variation in specifications on the part of the manufacturer. Manufacturers use recognizable names, such as “No. 2” coil-spring, to identify certain traps. However, there is no standardized system linking mechanical design features with trap names. The mechanical features of these traps are listed so that similar traps may be identified. The performance of anchoring systems was not specifically evaluated. However, methods of attachment are described for informational purposes.

Unmodified Jaws (Figures RA5a and RA5b)

Average Mechanical Description and Attributes

Inside jaw spread (at dog): 3 ¹¹/₁₆ inches

Inner width: 3 ³/₁₆ inches

Width at jaw hinge posts: 3 ¹/₂ inches

Jaw width: ³/₈ inch smooth round jaw

Jaw thickness: ¹/₈ inch

Main trap springs: Two 0.110 inch wire-diameter springs

Base plate: Not reinforced

Any trap that has similar specifications may be considered a BMP trap regardless of brand or source of modification, although performance information on all other BMP criteria (see Introduction: "Criteria for Evaluation of Trapping Devices" pages 4-6) needs to be considered as well. The trap tested was the Woodstream™ Victor No. 1 coil-spring trap, and it only met BMP criteria in the southeast region: Alabama, Arkansas, Florida, Georgia, Kentucky, Louisiana, Maryland, Mississippi, North Carolina, South Carolina, Virginia and Tennessee.

Additional Information

- Chain attachment used in trap testing: 6 ¹/₂ inch center-mounted with two swivels, one shock spring, and anchored with a stake.
- Selectivity features: Brass pan tension machine screw; pan tension was set to two pounds for testing, and checked and readjusted as needed after every capture; small jaw spread.
- Special considerations for practicality: Can be set in shallow water to improve selectivity.



Double Jaws (Figures RA6a, RA6b, RA6c, RA6d, RA6e, RA6f, RA6g)

Average Mechanical Description and Attributes

Inside jaw spread (at dog): 4 ⁵/₁₆ inches

Inner width: 4 ⁷/₁₆ inches

Width at jaw hinge posts: 4 ¹³/₁₆ inches

Jaw width: ¹/₂ inch

Jaw thickness: ¹/₈ inch

Main trap springs: Two 0.131 inch wire-diameter springs

Base plate: Not reinforced

Distance from trap pan with pan stop to bottom of auxiliary jaw when closed: 1 inch

Pan stop: Yes

Any trap that has similar specifications may be considered a BMP trap regardless of brand or source of modification, although performance information on all other BMP criteria (see Introduction: "Criteria for Evaluation of Trapping Devices" pages 4-6) needs to be considered as well. The trap tested was the Sleepy Creek™ No. 1 ¹/₂ coil-spring, modified with double-jaw.

Additional Information

- Chain attachment used in trap testing: 20 inch center-mounted with two swivels and anchored with a stake.
- Selectivity features: Brass pan tension machine screw; pan tension was set to two pounds for testing and checked and readjusted as needed after every capture.
- Special considerations for practicality: Can be set in shallow water to improve selectivity.

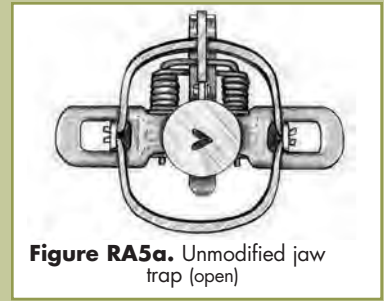

Figure RA5a. Unmodified jaw trap (open)

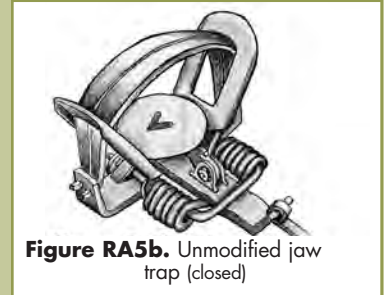

Figure RA5b. Unmodified jaw trap (closed)

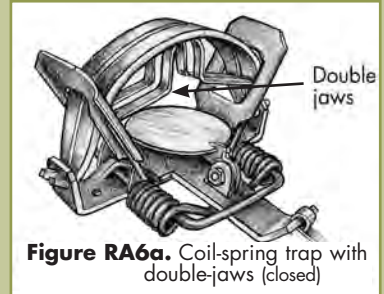

Figure RA6a. Coil-spring trap with double-jaws (closed)

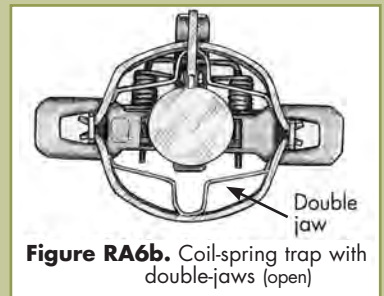

Figure RA6b. Coil-spring trap with double-jaws (open)



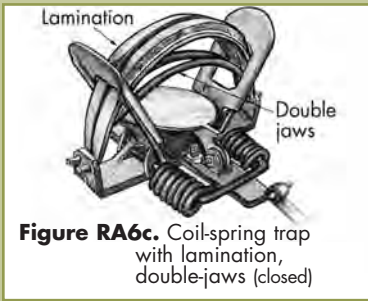

Figure RA6c. Coil-spring trap with lamination, double-jaws (closed)

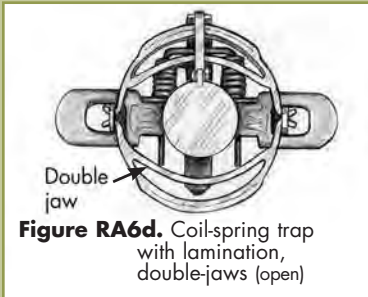

Figure RA6d. Coil-spring trap with lamination, double-jaws (open)

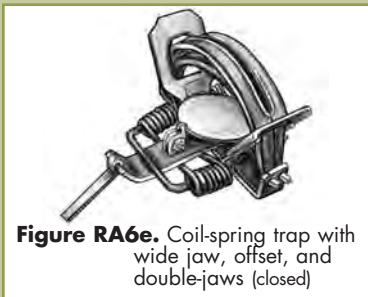

Figure RA6e. Coil-spring trap with wide jaw, offset, and double-jaws (closed)

Average Mechanical Description and Attributes

Inside jaw spread (at dog): 4 ⁹/₁₆ inches
 Inner width: 4 ⁵/₁₆ inches
 Width at jaw hinge posts: 4 ⁵/₈ inches
 Jaw width: ⁷/₁₆ inch
 Jaw thickness: ¹/₈ inch
 Jaw thickness with lamination: ⁵/₁₆ inch
 Lamination: ³/₁₆ inch, above-jaw lamination
 Main trap springs: Two 0.130 inch wire-diameter springs
 Base plate: Not reinforced
 Distance from trap pan with pan stop to bottom of auxiliary jaw when closed: 1 ¹/₈ inches
 Pan stop: Yes

Any trap that has similar specifications may be considered a BMP trap regardless of brand or source of modification, although performance information on all other BMP criteria (see Introduction: "Criteria for Evaluation of Trapping Devices" pages 4-6) needs to be considered as well. The trap tested was the Duke No. 1 ¹/₂ coil-spring trap, modified with double-jaw, laminated.

Additional Information

- Chain attachment used in trap testing: 30 inch center-mounted with two swivels and anchored with a stake.
- Selectivity features: Brass pan tension machine screw; pan tension was set to two pounds for testing and checked and readjusted as needed after every capture. Small jaw spread.
- Special considerations for practicality: Can be set in shallow water to improve selectivity.



Average Mechanical Description and Attributes

Inside jaw spread (at dog): 4 ¹/₂ inches
 Inner width: 4 ⁵/₁₆ inches
 Width at jaw hinge posts: 4 ¹¹/₁₆ inches
 Jaw width: ³/₈ inch
 Jaw thickness: ¹/₄ inch
 Jaw offset: ³/₁₆ inch
 Main trap springs: Two 0.122 inch wire-diameter springs
 Base plate: Reinforced with D-ring
 Distance from trap pan with pan stop to bottom of auxiliary jaw when closed: 1 ¹/₂ inches
 Pan stop: Yes

Any trap that has similar specifications may be considered a BMP trap regardless of brand or source of modification, although performance information on all other BMP criteria (see Introduction: "Criteria for Evaluation of Trapping Devices" pages 4-6) needs to be considered as well. The trap tested was the Sleepy Creek™ No. 1 ¹/₂ coil-spring, wide jaw, offset, modified with double-jaw.

Additional Information

- Chain attachment used in trap testing: 30 inch center-mounted with two swivels and anchored with a stake.
- Selectivity features: Brass pan tension machine screw; pan tension was set to two pounds for testing and checked and readjusted as needed after every capture.
- Special considerations for practicality: Can be set in shallow water to improve selectivity.



Average Mechanical Description and Attributes

Inside jaw spread (at dog): 4 1/2 inches

Inner width: 4 5/16 inches

Width at jaw hinge posts: 4 11/16 inches

Jaw width: 3/8 inch

Jaw thickness: 1/4 inch

Jaw offset: 3/16 inch

Main trap springs: Two 0.131 inch wire-diameter springs

Additional springs: Two 0.101 inch wire-diameter springs

Base plate: Reinforced with D-ring

Distance from trap pan with pan stop to bottom of auxiliary jaw when closed: 1 1/2 inches

Pan stop: Yes

Any trap that has similar specifications may be considered a BMP trap regardless of brand or source of modification, although performance information on all other BMP criteria (see Introduction: "Criteria for Evaluation of Trapping Devices" pages 4-6) needs to be considered as well. The trap tested was the Sleepy Creek™ No. 1 1/2 coil-spring, wide jaw, offset, modified with double-jaw, four-coiled.

Additional Information

- Chain attachment used in trap testing: 30 inch center-mounted with two swivels, one shock spring, and anchored with a stake.
- Selectivity features: Brass pan tension machine screw; pan tension was set to two pounds for testing and checked and readjusted as needed after every capture.
- Special considerations for practicality: Can be set in shallow water to improve selectivity.



Average Mechanical Description and Attributes

Inside jaw spread (at dog): 3 7/8 inches

Inner width: 3 1/8 inches

Width at jaw hinge posts: 3 7/16 inches

Jaw width: 1/2 inch

Jaw thickness: 1/8 inch

Jaw offset: 1/8 inch

Length of main trap springs: 4 3/8 inches

Thickness of main trap springs: 1/16 inch

Width of main trap springs: 1 1/2 narrowing to 5/8 inches

Base plate: Not reinforced

Distance from trap pan with pan stop to bottom of auxiliary jaw when closed: 7/8 inches

Pan stop: Yes

Any trap that has similar specifications may be considered a BMP trap regardless of brand or source of modification, although performance information on all other BMP criteria (see Introduction: "Criteria for Evaluation of Trapping Devices" pages 4-6)) needs to be considered as well. The trap tested was the Sleepy Creek™ No. 11 long-spring, double-jaw, offset.

Additional Information

- Chain attachment used in trap testing: 6 1/2 inch center-mounted with two swivels, one shock spring, and anchored with a stake.
- Selectivity features: Brass pan tension machine screw; pan tension was set to two pounds for testing and checked and readjusted as needed after every capture.
- Special considerations for practicality: Can be set in shallow water to improve selectivity.

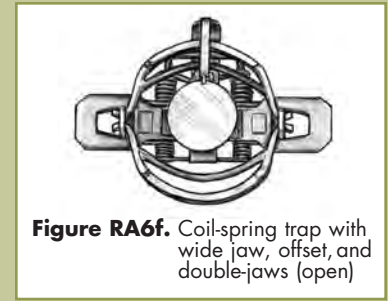

Figure RA6f. Coil-spring trap with wide jaw, offset, and double-jaws (open)

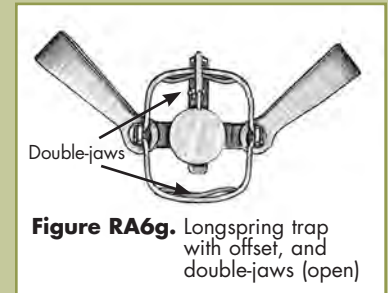

Figure RA6g. Longspring trap with offset, and double-jaws (open)





Figure RA7. Padded jaw trap (open)

Padded Jaw Foothold Traps (Figure RA7)

Average Mechanical Description and Attributes

Inside jaw spread (at dog): 4 1/2 inches

Inner width: 4 7/8 inches

Inside width at jaw hinge posts: 4 7/16 inches

Jaw width: 9/16 inch padded jaw

Jaw thickness: 3/8 inch

Main trap springs: Two 0.130 inch wire-diameter coil springs

Base plate: Not reinforced

Padding: Manufacturer supplied rubber pads

Any trap that has similar specifications may be considered a BMP trap regardless of brand or source of modification, although performance information on all other BMP criteria (see "Criteria for Evaluation of Trapping Devices": Introduction pages 4-6) needs to be considered as well. The trap tested was the Oneida™ Victor No. 1 1/2 Softcatch coil spring (Figure RA7).

Additional Information

- Chain attachment used in trap testing: 6 inch, center mounted with one swivel, one shock spring and anchored with a stake.
- Selectivity features: Brass pan tension machine screw; pan tension was set to two pounds for testing, and checked and readjusted as needed after every capture.
- Special considerations for practicality: Some damage to trap pads should be expected and will require occasional replacement as a normal part of trap maintenance and upkeep. Special care should be taken to prevent odor contamination of the rubber jaws. Avoid using petroleum-based dye directly on the rubber pads. This trap also meets all BMP criteria for Arctic fox, Gray fox, Red fox, Nutria, and Opossum.



Figure RA8. EGG Trap™

Enclosed Foothold Traps (Figures RA8–RA13)

Average Mechanical Description and Attributes

Casing material: Plastic

Opening diameter: 1 1/2 inches

Round-bar diameter: 0.125 inch

Depth of trigger: 2 7/8 inches

Trap springs: 0.125 inch

Any trap that has similar specifications may be considered a BMP trap regardless of brand or source of modification, although performance information on all other BMP criteria (see Introduction: "Criteria for Evaluation of Trapping Devices" pages 4-6) needs to be considered as well. The trap tested was the EGG™ Trap (Figure RA8).

Additional Information

- Chain attachment used in trap testing: 15 inch cable center-mounted with two swivels and anchored with a stake.
- Selectivity features: Opening to trigger restricted to 1 1/2 inches; enclosed trigger, recessed 2 7/8 inches from opening; trigger is pull-activated but can be modified for two-way action; and bait enclosed in casing of trap (hidden from view and access).
- Special considerations for practicality: Requires use of setting tools; disassembly required to set trap and to remove animal from trap; species-selective, best used for raccoons and opossums; requires use of bait or lure; some type of lubricant should be used on internal metal parts during storage; trap continues to function in freezing weather conditions; and can be set above ground to prevent trap from freezing solid into the ground during extreme cold.



Average Mechanical Description and Attributes

Casing material: Metal
Opening diameter: 1 1/2 inches
Round-bar diameter: 0.162 inch
Depth of trigger: 2 1/8 inches
Trap springs: 0.162 inch

Any trap that has similar specifications may be considered a BMP trap regardless of brand or source of modification, although performance information on all other BMP criteria (see Introduction: "Criteria for Evaluation of Trapping Devices" pages 4-6) needs to be considered as well. The trap tested was the Duffer Trap™ (Figure RA9).

Additional Information

- Chain attachment used in trap testing: 6 1/2 inch center-mounted with two swivels and anchored with a stake.
- Selectivity features: Opening to trigger restricted to 1 1/2 inches; enclosed trigger, recessed 2 1/8 inches from opening; trigger is pull-activated; and bait enclosed in casing of trap (hidden from view and access).
- Special considerations for practicality: Does not require setting tools; disassembly required to bait or remove animals; species-selective, best used for raccoons and opossums; requires use of bait or lure; some type of lubricant should be used on trigger mechanism during storage; trap continues to function in freezing weather conditions; and can be set above ground to prevent trap from freezing solid into the ground during extreme cold.



Average Mechanical Description and Attributes

Casing material: Metal
Opening diameter: 1 1/2 inch
Round-bar diameter: 0.118 inch
Depth of trigger: 2 9/16 inches
Trap springs: 0.118 inch

Any trap that has similar specifications may be considered a BMP trap regardless of brand or source of modification, although performance information on all other BMP criteria (see Introduction: "Criteria for Evaluation of Trapping Devices" pages 4-6) needs to be considered as well. The trap tested was the Lil' Grizz Get'rz™ Trap (Figure RA10).

Additional Information

- Chain attachment used in trap testing: 6 1/2 inch center-mounted with two swivels, one shock spring, and anchored with a stake.
- Selectivity features: Opening to trigger restricted to 1 1/2 inches; enclosed trigger, recessed 2 9/16 inches from opening; trigger is pull-activated; and bait enclosed in casing of trap (hidden from view and access).
- Special considerations for practicality: Does not require setting tools or disassembly to bait or remove animals; species-selective, best used for raccoons and opossums; requires use of bait or lure; some type of lubricant should be used on trigger mechanism during storage; and trap continues to function in freezing weather conditions. To prevent trap from freezing solid into ground, trap can be anchored into a block of wood set on top of the ground.



Figure RA9. Duffer Trap™ rear view



Figure RA10. Lil' Grizz Get'rz™ trap (unset)





Figure RA11.

Average Mechanical Description and Attributes

Casing material: Metal
 Opening diameter: 1 ¼ inches
 Round-bar diameter: 0.120 inch
 Depth of trigger: 2 9/16 inches
 Trigger activation: Pull
 Trap springs: 0.120 inch

Any trap that has similar specifications may be considered a BMP trap regardless of brand or source of modification, although performance information on all other BMP criteria (see "Criteria for Evaluation of Trapping Devices": Introduction pages 4-6) needs to be considered as well. The trap tested was the Duke "DP" Dog Proof Raccoon Trap™ (Figure RA11).

Additional Information

- Chain attachment used in trap testing: 12 inch center-mounted with two swivels, one shock spring, and anchored with a stake.
- Selectivity features: Opening to trigger restricted to 1 ¼ inches; enclosed trigger, recessed 2 9/16 inches from opening; trigger is pull-activated; bait enclosed in casing of trap (hidden from view and access).
- Special considerations for practicality: Does not require setting tools, or disassembly to bait or remove animals; species-selective, best used for raccoons and opossums; requires use of bait or lure; some type of lubricant should be used on trigger mechanism during storage; trap continues to function in freezing weather conditions. To prevent trap from freezing solid into ground, trap can be anchored into a block of wood set on top of the ground.



Figure RA12.

Average Mechanical Description and Attributes

Casing material: Metal
 Opening diameter: 1 ¼ inches
 Round-bar diameter: 0.120 inch
 Depth of trigger: 2 3/8 inches
 Trigger activation: Push or pull
 Trap springs: 0.120 inch

Any trap that has similar specifications may be considered a BMP trap regardless of brand or source of modification, although performance information on all other BMP criteria (see "Criteria for Evaluation of Trapping Devices": Introduction pages 4-6) needs to be considered as well. The trap tested was the Z-Trap™ (Figure RA12).

Additional Information

- Chain attachment used in trap testing: 12 inch center-mounted with two swivels, one shock spring, and anchored with a stake.
- Selectivity features: Opening to trigger restricted to 1 ¼ inches; enclosed trigger, recessed 2 3/8 inches from opening; trigger is pull-activated; bait enclosed in casing of trap (hidden from view and access).
- Special considerations for practicality: Does not require setting tools, or disassembly to bait or remove animals; species-selective, best used for raccoons and opossums; requires use of bait or lure; some type of lubricant should be used on trigger mechanism during storage; trap continues to function in freezing weather conditions. To prevent trap from freezing solid into ground, trap can be anchored into a block of wood set on top of the ground.



Average Mechanical Description and Attributes

Casing material: Metal
Opening diameter: 1 ³/₈ inches
Round-bar diameter: 0.120 inch
Depth of trigger: 2 ⁵/₈ inches
Trigger activation: Pull
Trap springs: 0.120 inch

Any trap that has similar specifications may be considered a BMP trap regardless of brand or source of modification, although performance information on all other BMP criteria (see "Criteria for Evaluation of Trapping Devices": Introduction pages 4-6) needs to be considered as well. The trap tested was the Bridger T-3 Raccoon Trap™ (Figure RA13).

Additional Information

- Chain attachment used in trap testing: 12 inch center-mounted with two swivels, one shock spring, and anchored with a stake.
- Selectivity features: Opening to trigger restricted to 1 ³/₈ inches; enclosed trigger, recessed 2 ⁵/₈ inches from opening; trigger is pull-activated; bait enclosed in casing of trap (hidden from view and access).
- Special considerations for practicality: Does not require setting tools, or disassembly to bait or remove animals; species-selective, best used for raccoons and opossums; requires use of bait or lure; some type of lubricant should be used on trigger mechanism during storage; trap continues to function in freezing weather conditions. To prevent trap from freezing solid into ground, trap can be anchored into a block of wood set on top of the ground.



Figure RA13.





Figure RA14. Bélisle™ Super X bodygrip (set position)

Bodygrip Traps (Figures RA14–RA38)

Average Mechanical Description and Attributes

Height of trap window: 6 inches
 Width of trap window: 6 ³/₁₆ inches
 Diameter of frame wire: ³/₁₆ inch
 Diameter of spring wire: ³/₁₆ inch
 Additional clamping bar: No
 Safety features: Spring latches

Any trap that has similar specifications may be considered a BMP trap regardless of brand or source of modification, although performance information on all other BMP criteria (see Introduction: “Criteria for Evaluation of Trapping Devices” pages 4-6) needs to be considered as well. The trap tested was the Bélisle™ Super X 160 (Figure RA14).

Additional Information

- Selectivity features: Small jaw spread limits access by most dog breeds; can be recessed in a cubby to increase selectivity or set in a tree or above ground. Proper setting techniques are best learned from trapper education materials or from experienced trappers.
- Practicality considerations: Can be set along trails, in a tree or above ground.
- Safety considerations: Use of setting tongs, safety latches and safety gripper is recommended.



Average Mechanical Description and Attributes

Height of trap window: 6 ³/₁₆ inches
 Width of trap window: 6 ⁵/₁₆ inches
 Diameter of frame wire: ³/₁₆ inch
 Diameter of spring wire: ³/₁₆ inch
 Additional clamping bar: No
 Safety features: Spring latches

Any trap that has similar specifications may be considered a BMP trap regardless of brand or source of modification, although performance information on all other BMP criteria (see Introduction: “Criteria for Evaluation of Trapping Devices” pages 4-6) needs to be considered as well. The trap tested was the BMI™ 160. (Figure RA15).

Additional Information

- Selectivity features: Small jaw spread limits access by most dog breeds; can be recessed in a cubby to increase selectivity or set in a tree or above ground. Proper setting techniques are best learned from trapper education materials or from experienced trappers.
- Practicality considerations: Can be set along trails, in a tree or above ground.
- Safety considerations: Use of setting tongs, safety latches and safety gripper is recommended.



Figure RA15. BMI™ 160 bodygrip (set)

Average Mechanical Description and Attributes

Height of trap window: 6 ¹/₁₆ inches
Width of trap window: 6 ¹/₈ inches
Diameter of frame wire: ³/₁₆ inches
Diameter of spring wire: ³/₁₆ inch
Additional clamping bar: No
Safety features: Spring latches

Any trap that has similar specifications may be considered a BMP trap regardless of brand or source of modification, although performance information on all other BMP criteria (see Introduction: "Criteria for Evaluation of Trapping Devices" pages 4-6) needs to be considered as well. The trap tested was the LDL™ 160 (Figure RA16).

Additional Information

- Selectivity features: Small jaw spread limits access by most dog breeds; can be recessed in a cubby to increase selectivity or set in a tree or above ground. Proper setting techniques are best learned from trapper education materials or from experienced trappers.
- Practicality considerations: Can be set along trails, in a tree or above ground.
- Safety considerations: Use of setting tongs, safety latches and safety gripper is recommended.



Average Mechanical Description and Attributes

Height of trap window: 6 inches
Width of trap window: 6 inches
Diameter of frame wire: ¹/₄ inch
Diameter of spring wire: ³/₁₆ inch
Additional clamping bar: No
Safety features: Spring latches

Any trap that has similar specifications may be considered a BMP trap regardless of brand or source of modification, although performance information on all other BMP criteria (see Introduction: "Criteria for Evaluation of Trapping Devices" pages 4-6) needs to be considered as well. The trap tested was the Rudy™160 (Figure RA17).

Additional Information

- Selectivity features: Small jaw spread limits access by most dog breeds; can be recessed in a cubby to increase selectivity or set in a tree or above ground. Proper setting techniques are best learned from trapper education materials or from experienced trappers.
- Practicality considerations: Can be set along trails, in a tree or above ground.
- Safety considerations: Use of setting tongs, safety latches and safety gripper is recommended.

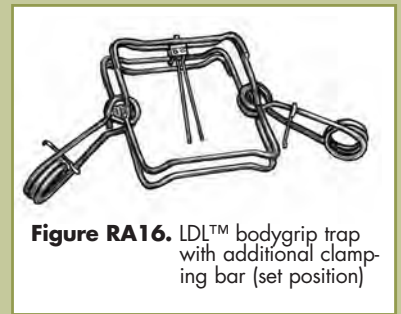

Figure RA16. LDL™ bodygrip trap with additional clamping bar (set position)

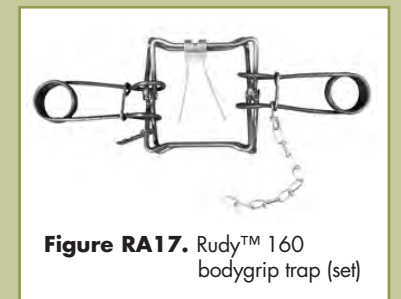

Figure RA17. Rudy™ 160 bodygrip trap (set)



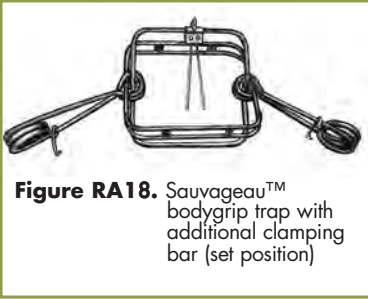

Figure RA18. Sauvageau™ bodygrip trap with additional clamping bar (set position)

Average Mechanical Description and Attributes

Height of trap window: 6 1/16 inches
 Width of trap window: 6 inches
 Diameter of frame wire: 1/4 inch
 Diameter of spring wire: 1/4 inch
 Clamping bar: Yes
 Safety features: Spring latches

Any trap that has similar specifications may be considered a BMP trap regardless of brand or source of modification, although performance information on all other BMP criteria (see Introduction: "Criteria for Evaluation of Trapping Devices" pages 4-6) needs to be considered as well. The trap tested was the Sauvageau™ 2001-6 (Figure RA18).

Additional Information

- Selectivity features: Small jaw spread limits access by most dog breeds; can be recessed in a cubby to increase selectivity or set in a tree or above ground. Proper setting techniques are best learned from trapper education materials or from experienced trappers.
- Practicality considerations: Can be set along trails, in a tree or above ground.
- Safety considerations: Use of setting tongs, safety latches and safety gripper is recommended.



Figure RA19. Victor™ 160 bodygrip trap (set)

Average Mechanical Description and Attributes

Height of trap window: 6 inches
 Width of trap window: 6 1/16 inches
 Diameter of frame wire: 3/16 inch
 Diameter of spring wire: 3/16 inch
 Additional clamping bar: No
 Safety features: Spring latches

Any trap that has similar specifications may be considered a BMP trap regardless of brand or source of modification, although performance information on all other BMP criteria (see Introduction: "Criteria for Evaluation of Trapping Devices" pages 4-6) needs to be considered as well. The trap tested was the Woodstream™ Oneida Victor 160 (Figure RA19).

Additional Information

- Selectivity features: Small jaw spread limits access by most dog breeds; can be recessed in a cubby to increase selectivity or set in a tree or above ground. Proper setting techniques are best learned from trapper education materials or from experienced trappers.
- Practicality considerations: Can be set along trails, in a tree or above ground.
- Safety considerations: Use of setting tongs, safety latches and safety gripper is recommended.



Average Mechanical Description and Attributes

Height of trap window: 7 1/2 inches

Width of trap window: 7 1/8 inches

Diameter of frame wire: 1/4 inch

Diameter of spring wire: 1/4 inch

Additional clamping bar: No

Safety features: Spring latches

Any trap that has similar specifications may be considered a BMP trap regardless of brand or source of modification, although performance information on all other BMP criteria (see Introduction: "Criteria for Evaluation of Trapping Devices" pages 4-6) needs to be considered as well. The trap tested was the Bélisle™ Classic 220 (Figure RA20).

Additional Information

- Selectivity features: Small jaw spread limits access by most dog breeds; can be recessed in a cubby to increase selectivity or set in a tree or above ground. Proper setting techniques are best learned from trapper education materials or from experienced trappers.
- Practicality considerations: Can be set along trails, in a tree or above ground.
- Safety considerations: Use of setting tongs, safety latches and safety gripper is recommended.



Average Mechanical Description and Attributes

Height of trap window: 7 1/8 inches

Width of trap window: 7 1/8 inches

Diameter of frame wire: 1/4 inch

Diameter of spring wire: 1/4 inch

Additional clamping bar: No

Safety features: Spring latches

Any trap that has similar specifications may be considered a BMP trap regardless of brand or source of modification, although performance information on all other BMP criteria (see Introduction: "Criteria for Evaluation of Trapping Devices" pages 4-6) needs to be considered as well. The trap tested was the Bélisle™ Super X 220 (Figure RA21).

Additional Information

- Selectivity features: Small jaw spread limits access by most dog breeds; can be recessed in a cubby to increase selectivity or set in a tree or above ground. Proper setting techniques are best learned from trapper education materials or from experienced trappers.
- Practicality considerations: Can be set along trails, in a tree or above ground.
- Safety considerations: Use of setting tongs, safety latches and safety gripper is recommended.



Figure RA20. Belisle™ Classic 220 bodygrip trap (set)



Figure RA21. Belisle™ Super X 220 bodygrip trap (set)





Figure RA22. Bridger™ 220 bodygrip trap (set)

Average Mechanical Description and Attributes

Height of trap window: 6 ⁵/₈ inches

Width of trap window: 7 ³/₈ inches

Diameter of frame wire: ¹/₄ inch

Diameter of spring wire: ¹/₄ inch

Additional clamping bar: No

Safety features: Spring latches

Any trap that has similar specifications may be considered a BMP trap regardless of brand or source of modification, although performance information on all other BMP criteria (see Introduction: "Criteria for Evaluation of Trapping Devices" pages 4-6) needs to be considered as well. The trap tested was the Bridger™ 220 (Figure RA22).

Additional Information

- Selectivity features: Small jaw spread limits access by most dog breeds; can be recessed in a cubby to increase selectivity or set in a tree or above ground. Proper setting techniques are best learned from trapper education materials or from experienced trappers.
- Practicality considerations: Can be set along trails, in a tree or above ground.
- Safety considerations: Use of setting tongs, safety latches and safety gripper is recommended.



Figure RA23. BMI™ 220 bodygrip trap (set)

Average Mechanical Description and Attributes

Height of trap window: 7 ¹/₁₆ inches

Width of trap window: 7 ⁵/₁₆ inches

Diameter of frame wire: ¹/₄ inch

Diameter of spring wire: ¹/₄ inch

Additional clamping bar: No

Safety features: Spring latches

Any trap that has similar specifications may be considered a BMP trap regardless of brand or source of modification, although performance information on all other BMP criteria (see Introduction: "Criteria for Evaluation of Trapping Devices" pages 4-6) needs to be considered as well. The trap tested was the BMI™ 220 (Figure RA23).

Additional Information

- Selectivity features: Small jaw spread limits access by most dog breeds; can be recessed in a cubby to increase selectivity or set in a tree or above ground. Proper setting techniques are best learned from trapper education materials or from experienced trappers.
- Practicality considerations: Can be set along trails, in a tree or above ground.
- Safety considerations: Use of setting tongs, safety latches and safety gripper is recommended.



Average Mechanical Description and Attributes

Height of trap window: 7 inches
Width of trap window: 7 ³/₈ inches
Diameter of frame wire: 1/4 inch
Diameter of spring wire: 1/4 inch
Additional clamping bar: No
Safety features: Spring latches

Any trap that has similar specifications may be considered a BMP trap regardless of brand or source of modification, although performance information on all other BMP criteria (see Introduction: "Criteria for Evaluation of Trapping Devices" pages 4-6) needs to be considered as well. The trap tested was the BMI™ 220 Magnum (Figure RA24).

Additional Information

- Selectivity features: Small jaw spread limits access by most dog breeds; can be recessed in a cubby to increase selectivity or set in a tree or above ground. Proper setting techniques are best learned from trapper education materials or from experienced trappers.
- Practicality considerations: Can be set along trails, in a tree or above ground.
- Safety considerations: Use of setting tongs, safety latches and safety gripper is recommended.



Average Mechanical Description and Attributes

Height of trap window: 7 ¹/₈ inches
Width of trap window: 7 ¹/₈ inches
Diameter of frame wire: 1/4 inch
Diameter of spring wire: 1/4 inch
Additional clamping bar: Yes
Safety features: Spring latches

Any trap that has similar specifications may be considered a BMP trap regardless of brand or source of modification, although performance information on all other BMP criteria (see Introduction: "Criteria for Evaluation of Trapping Devices" pages 4-6) needs to be considered as well. The trap tested was the LDL™ 220 (Figure RA25).

Additional Information

- Selectivity features: Small jaw spread limits access by most dog breeds; can be recessed in a cubby to increase selectivity or set in a tree or above ground. Proper setting techniques are best learned from trapper education materials or from experienced trappers.
- Practicality considerations: Can be set along trails, in a tree or above ground.
- Safety considerations: Use of setting tongs, safety latches and safety gripper is recommended.

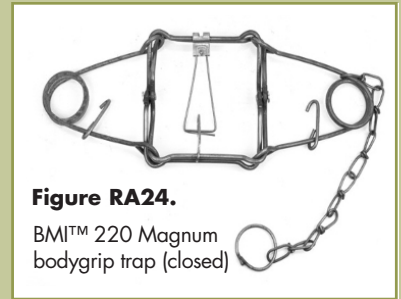

Figure RA24.

BMI™ 220 Magnum
bodygrip trap (closed)



Figure RA25. LDL™ 220 bodygrip
trap (set)



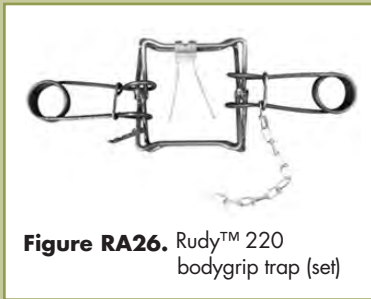

Figure RA26. Rudy™ 220 bodygrip trap (set)

Average Mechanical Description and Attributes

Height of trap window: 6 ³/₄ inches
 Width of trap window: 7 ¹/₄ inches
 Diameter of frame wire: ¹/₄ inch
 Diameter of spring wire: ¹/₄ inch
 Additional clamping bar: No
 Safety features: Spring latches

Any trap that has similar specifications may be considered a BMP trap regardless of brand or source of modification, although performance information on all other BMP criteria (see Introduction: "Criteria for Evaluation of Trapping Devices" pages 4-6) needs to be considered as well. The trap tested was the Rudy™ 220 (Figure RA26).

Additional Information

- Selectivity features: Small jaw spread limits access by most dog breeds; can be recessed in a cubby to increase selectivity or set in a tree or above ground. Proper setting techniques are best learned from trapper education materials or from experienced trappers.
- Practicality considerations: Can be set along trails, in a tree or above ground.
- Safety considerations: Use of setting tongs, safety latches and safety gripper is recommended.



Figure RA27. Sauvageau™ 2001-7 bodygrip trap (set)

Average Mechanical Description and Attributes

Height of trap window: 7 inches
 Width of trap window: 7 inches
 Diameter of frame wire: ¹/₄ inch
 Diameter of spring wire: ¹/₄ inch
 Additional clamping bar: Yes
 Safety features: Spring latches

Any trap that has similar specifications may be considered a BMP trap regardless of brand or source of modification, although performance information on all other BMP criteria (see Introduction: "Criteria for Evaluation of Trapping Devices" pages 4-6) needs to be considered as well. The trap tested was the Sauvageau™ 2001-7 (Figure RA27).

Additional Information

- Selectivity features: Small jaw spread limits access by most dog breeds; can be recessed in a cubby to increase selectivity or set in a tree or above ground. Proper setting techniques are best learned from trapper education materials or from experienced trappers.
- Practicality considerations: Can be set along trails, in a tree or above ground.
- Safety considerations: Use of setting tongs, safety latches and safety gripper is recommended.



Average Mechanical Description and Attributes

Height of trap window: 6 ⁵/₈ inches

Width of trap window: 7 inches

Diameter of frame wire: 1/4 inch

Diameter of spring wire: 1/4 inch

Additional clamping bar: No

Safety features: Spring latches

Any trap that has similar specifications may be considered a BMP trap regardless of brand or source of modification, although performance information on all other BMP criteria (see Introduction: "Criteria for Evaluation of Trapping Devices" pages 4-6) needs to be considered as well. The trap tested was the Species Specific™ 220 Half-Magnum (Figure RA28).

Additional Information

- Selectivity features: Small jaw spread limits access by most dog breeds; can be recessed in a cubby to increase selectivity or set in a tree or above ground. Proper setting techniques are best learned from trapper education materials or from experienced trappers.
- Practicality considerations: Can be set along trails, in a tree or above ground.
- Safety considerations: Use of setting tongs, safety latches and safety gripper is recommended.



Average Mechanical Description and Attributes

Height of trap window: 6 ¹⁵/₁₆ inches

Width of trap window: 7 inches

Diameter of frame wire: 1/4 inch

Diameter of spring wire: 1/4 inch

Additional clamping bar: No

Safety features: Spring latches

Any trap that has similar specifications may be considered a BMP trap regardless of brand or source of modification, although performance information on all other BMP criteria (see Introduction: "Criteria for Evaluation of Trapping Devices" pages 4-6) needs to be considered as well. The trap tested was the Woodstream™ Oneida Victor 220 (Figure RA29).

Additional Information

- Selectivity features: Small jaw spread limits access by most dog breeds; can be recessed in a cubby to increase selectivity or set in a tree or above ground. Proper setting techniques are best learned from trapper education materials or from experienced trappers.
- Practicality considerations: Can be set along trails, in a tree or above ground.
- Safety considerations: Use of setting tongs, safety latches and safety gripper is recommended.



Figure RA28. Species Specific™ 220 Half Magnum bodygrip trap (set)



Figure RA29. Victor™ 220 bodygrip trap (set)





Figure RA30. Sauvageau™ 2001-8 bodygrip trap (set)

Average Mechanical Description and Attributes

Height of trap window: 8 inches
 Width of trap window: 8 ³/₁₆ inches
 Diameter of frame wire: ⁵/₁₆ inch
 Diameter of spring wire: ⁵/₁₆ inch
 Additional clamping bar: Yes
 Safety features: Spring latches

Any trap that has similar specifications may be considered a BMP trap regardless of brand or source of modification, although performance information on all other BMP criteria (see Introduction: "Criteria for Evaluation of Trapping Devices" pages 4-6) needs to be considered as well. The trap tested was the Sauvageau™ 2001-8 (Figure RA30).

Additional Information

- Selectivity features: Small jaw spread limits access by most dog breeds; can be recessed in a cubby to increase selectivity or set in a tree or above ground. Proper setting techniques are best learned from trapper education materials or from experienced trappers.
- Practicality considerations: Can be set along trails, in a tree or above ground.
- Safety considerations: Use of setting tongs, safety latches and safety gripper is recommended.



Average Mechanical Description and Attributes

Height of trap window: 5 inches
 Width of trap window: 4 ¹³/₁₆ inches
 Diameter of frame wire: ³/₁₆ inch
 Diameter of spring wire: ³/₁₆ inch
 Additional clamping bar: None
 Safety features: Safety latches on springs

Any trap that has similar specifications may be considered a BMP trap regardless of brand or source of modification, although performance information on all other BMP criteria (see "Criteria for Evaluation of Trapping Devices": Introduction pages 4-6) needs to be considered as well. The trap tested was the Northwoods™ 155 bodygrip trap (Figure RA31).

Additional Information

- Selectivity features: Small jaw spread limits access by most dog breeds; can be recessed in a cubby to increase selectivity; can be set in a tree or above ground. Proper setting techniques are best learned from trapper education materials or from experienced trappers.
- Safety considerations: Use of setting tongs, safety latches, and safety gripper is recommended.
- Special considerations for practicality: This device also meets BMP criteria for American marten



Figure RA31.

Average Mechanical Description and Attributes

Height of trap window: 6 1/8 inches

Width of trap window: 6 inches

Diameter of frame wire: 3/16 inch

Diameter of spring wire: 3/16 inch

Additional clamping bar: None

Safety features: Safety latches on springs

Any trap that has similar specifications may be considered a BMP trap regardless of brand or source of modification, although performance information on all other BMP criteria (see "Criteria for Evaluation of Trapping Devices": Introduction pages 4-6) needs to be considered as well. The trap tested was the Bridger™ 160 bodygrip trap (Figure RA32).

Additional Information

- Selectivity features: Small jaw spread limits access by most dog breeds; can be recessed in a cubby to increase selectivity; can be set in a tree or above ground. Proper setting techniques are best learned from trapper education materials or from experienced trappers.
- Safety considerations: Use of setting tongs, safety latches, and safety gripper is recommended.



Average Mechanical Description and Attributes

Height of trap window: 5 7/8 inches

Width of trap window: 5 7/8 inches

Diameter of frame wire: 3/16 inch

Diameter of spring wire: 3/16 inch

Additional clamping bar: None

Safety features: Safety latches on springs

Any trap that has similar specifications may be considered a BMP trap regardless of brand or source of modification, although performance information on all other BMP criteria (see "Criteria for Evaluation of Trapping Devices": Introduction pages 4-6) needs to be considered as well. The trap tested was the Duke™ 160 bodygrip trap (Figure RA33).

Additional Information

- Selectivity features: Small jaw spread limits access by most dog breeds; can be recessed in a cubby to increase selectivity; can be set in a tree or above ground. Proper setting techniques are best learned from trapper education materials or from experienced trappers.
- Safety considerations: Use of setting tongs, safety latches, and safety gripper is recommended.



Figure RA32.



Figure RA33.



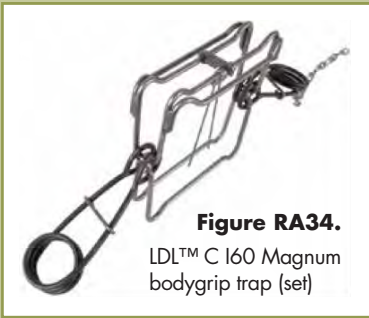

Figure RA34.
LDL™ C 160 Magnum
bodygrip trap (set)

Average Mechanical Description and Attributes

Height of trap window: 6 inches
 Width of trap window: 6 1/16 inches
 Diameter of frame wire: 3/16 inch
 Diameter of spring wire: 3/16 inch
 Additional clamping bar: None
 Safety features: Safety latches on springs

Any trap that has similar specifications may be considered a BMP trap regardless of brand or source of modification, although performance information on all other BMP criteria (see "Criteria for Evaluation of Trapping Devices": Introduction pages 4-6) needs to be considered as well. The trap tested was the LDL C™ 160 Magnum bodygrip trap (Figure RA34).

Additional Information

- Selectivity features: Small jaw spread limits access by most dog breeds; can be recessed in a cubby to increase selectivity; can be set in a tree or above ground. Proper setting techniques are best learned from trapper education materials or from experienced trappers.
- Safety considerations: Use of setting tongs, safety latches, and safety gripper is recommended.

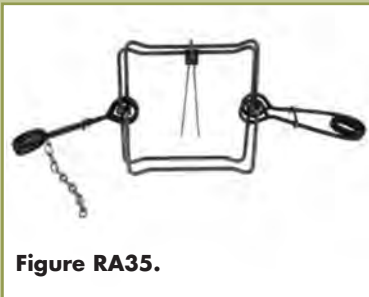

Figure RA35.

Average Mechanical Description and Attributes

Height of trap window: 6 1/4 inches
 Width of trap window: 5 7/8 inches
 Diameter of frame wire: 3/16 inch
 Diameter of spring wire: 3/16 inch
 Additional clamping bar: None
 Safety features: Safety latches on springs

Any trap that has similar specifications may be considered a BMP trap regardless of brand or source of modification, although performance information on all other BMP criteria (see "Criteria for Evaluation of Trapping Devices": Introduction pages 4-6) needs to be considered as well. The trap tested was the Rudy™ 160 Plus bodygrip trap (Figure RA35).

Additional Information

- Selectivity features: Small jaw spread limits access by most dog breeds; can be recessed in a cubby to increase selectivity; can be set in a tree or above ground. Proper setting techniques are best learned from trapper education materials or from experienced trappers.
- Safety considerations: Use of setting tongs, safety latches, and safety gripper is recommended.



Average Mechanical Description and Attributes

Height of trap window: 6 1/8 inches

Width of trap window: 7 3/4 inches

Diameter of frame wire: 1/4 inch

Diameter of spring wire: 1/4 inch

Additional clamping bar: None

Safety features: Safety latches on springs

Any trap that has similar specifications may be considered a BMP trap regardless of brand or source of modification, although performance information on all other BMP criteria (see "Criteria for Evaluation of Trapping Devices": Introduction pages 4-6) needs to be considered as well. The trap tested was the Duke™ 220 bodygrip trap (Figure RA36).

Additional Information

- Selectivity features: Small jaw spread limits access by most dog breeds; can be recessed in a cubby to increase selectivity; can be set in a tree or above ground. Proper setting techniques are best learned from trapper education materials or from experienced trappers.
- Safety considerations: Use of setting tongs, safety latches, and safety gripper is recommended.



Average Mechanical Description and Attributes

Height of trap window: 7 inches

Width of trap window: 7 1/16 inches

Diameter of frame wire: 1/4 inch

Diameter of spring wire: 1/4 inch

Additional clamping bar: None

Safety features: Safety latches on springs

Any trap that has similar specifications may be considered a BMP trap regardless of brand or source of modification, although performance information on all other BMP criteria (see "Criteria for Evaluation of Trapping Devices": Introduction pages 4-6) needs to be considered as well. The trap tested was the LDL C™ 220 Magnum bodygrip trap (Figure RA37).

Additional Information

- Selectivity features: Small jaw spread limits access by most dog breeds; can be recessed in a cubby to increase selectivity; can be set in a tree or above ground. Proper setting techniques are best learned from trapper education materials or from experienced trappers.
- Safety considerations: Use of setting tongs, safety latches, and safety gripper is recommended.
- Special considerations for practicality: This device also meets BMP criteria for fisher and river otter

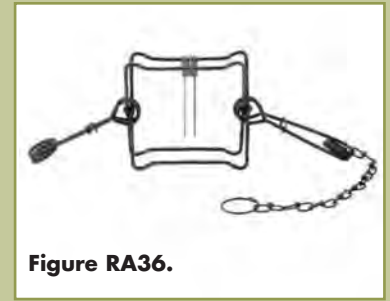

Figure RA36.

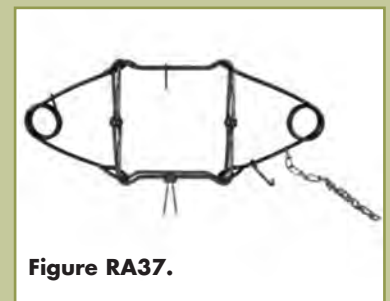

Figure RA37.



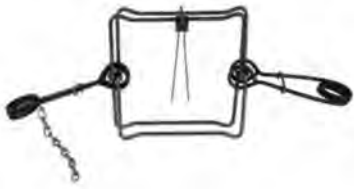

Figure RA38.

Average Mechanical Description and Attributes

Height of trap window: 7 inches

Width of trap window: 7 inches

Diameter of frame wire: ¼ inch

Diameter of spring wire: ¼ inch

Additional clamping bar: None, but does have a magnum bend which eliminates the gap between the jaws when the trap is closed.

Safety features: Safety latches on springs

Any trap that has similar specifications may be considered a BMP trap regardless of brand or source of modification, although performance information on all other BMP criteria (see “Criteria for Evaluation of Trapping Devices”: Introduction pages 4-6) needs to be considered as well. The trap tested was the Rudy™ 220 Plus bodygrip trap (Figure RA38).

Additional Information

- Selectivity features: Small jaw spread limits access by most dog breeds; can be recessed in a cubby to increase selectivity; can be set in a tree or above ground. Proper setting techniques are best learned from trapper education materials or from experienced trappers.
- Safety considerations: Use of setting tongs, safety latches, and safety gripper is recommended.
- Special considerations for practicality: This device also meets BMP criteria for fisher and river otter.



Cage Traps (Figure RA39–RA46)

Average Mechanical Description and Attributes

Cage material, and mesh size: 12 gauge galvanized steel wire mesh, 1 x 2 inches

Cage size (height x width x length): 12.75 x 10 x 32 inches

Door size (width x height): 10 x 12 inches

Weight: 14 pounds

Collapsed size (if applicable): Non-collapsing (rigid)



Figure RA39. Cage trap

Any trap that has similar specifications may be considered a BMP trap regardless of brand or source of modification, although performance information on all other BMP criteria (see Introduction: “Criteria for Evaluation of Trapping Devices” pages 4-6) needs to be considered as well. The trap tested was the Tomahawk™ Cage Trap, No. 108 (Figure RA39).

Additional Information

- Selectivity features: Limited opening size and length restricts large animals; Can be set in shallow water to improve selectivity.
- Special considerations for practicality: Versatile set options (baited sets and blind sets only with double doors); can be used for multiple furbearer species in same sets; large and easily seen (difficult to conceal completely); bulky—requires space for transport and storage (though folding models are available); easy to operate, requires little training; can be used to transport captured animals; captured animals are easily released; and continues to operate in freezing weather conditions.

Average Mechanical Description and Attributes

Cage material, and mesh size: 12 gauge galvanized steel wire mesh, 1 x 2 inches
Cage size (length x width x height): 32 x 10 x 12 inches
Door size (width x height): 10 x 12
Door material: solid metal
Weight: 13 pounds
Collapsed size (if applicable): Non-collapsing (rigid)

Any trap that has similar specifications may be considered a BMP trap regardless of brand or source of modification, although performance information on all other BMP criteria (see “Criteria for Evaluation of Trapping Devices”: Introduction pages 4-6) needs to be considered as well. The trap tested was the Havahart™ Cage Trap, No 1079 (Figure RA40).



Figure RA40.

Additional Information

- Selectivity features: Limited opening size and length restricts large animals; Can be set in shallow water to improve selectivity.
- Special considerations for practicality: Versatile set options (baited sets; blind sets only with double doors); can be used for multiple furbearer species in same sets; large and easily seen (difficult to conceal completely); bulky—requires space for transport and storage (though folding models are available); easy to operate—requires little training; can be used to transport captured animals; captured animals are easily released; continues to operate in freezing weather conditions.



Average Mechanical Description and Attributes

Cage material, and mesh size: 14 gauge galvanized steel wire mesh, 1 x 1 inches
Cage size (length x width x height): 42 x 15 x 15 inches
Door size (width x height): 15 x 15
Door material: Wire mesh
Weight: 15 pounds
Collapsed size (if applicable): Non-collapsing (rigid)

Any trap that has similar specifications may be considered a BMP trap regardless of brand or source of modification, although performance information on all other BMP criteria (see “Criteria for Evaluation of Trapping Devices”: Introduction pages 4-6) needs to be considered as well. The trap tested was the Havahart™ Cage Trap, No 1081 (Figure RA41).



Figure RA41.

Additional Information

- Selectivity features: Limited opening size and length restricts large animals; Can be set in shallow water to improve selectivity.
- Special considerations for practicality: Versatile set options (baited sets; blind sets only with double doors); can be used for multiple furbearer species in same sets; large and easily seen (difficult to conceal completely); bulky—requires space for transport and storage (though folding models are available); easy to operate—requires little training; can be used to transport captured animals; captured animals are easily released; continues to operate in freezing weather conditions.





Figure RA42.

Average Mechanical Description and Attributes

Cage material, and mesh size: 12 gauge galvanized steel wire mesh, 1 x 2 inches

Cage size (length x width x height): 32 x 10 ½ x 12 inches

Door size (width x height): 10 ½ x 12

Door material: Solid metal

Weight: 13 pounds

Collapsed size (if applicable): Non-collapsing (rigid)

Any trap that has similar specifications may be considered a BMP trap regardless of brand or source of modification, although performance information on all other BMP criteria (see “Criteria for Evaluation of Trapping Devices”: Introduction pages 4-6) needs to be considered as well. The trap tested was the Havahart™ Cage Trap, No 1085 (Figure RA42).

Additional Information

- Selectivity features: Limited opening size and length restricts large animals; Can be set in shallow water to improve selectivity.
- Special considerations for practicality: Versatile set options (baited sets; blind sets only with double doors); can be used for multiple furbearer species in same sets; large and easily seen (difficult to conceal completely); bulky—requires space for transport and storage (though folding models are available); easy to operate—requires little training; can be used to transport captured animals; captured animals are easily released; continues to operate in freezing weather conditions.



Figure RA43.

Average Mechanical Description and Attributes

Cage material, and mesh size: 12 gauge galvanized steel wire mesh, 1 x 2 inches

Cage size (length x width x height): 42 x 12 x 12 inches

Door size (width x height): 12 x 12

Door material: Wire mesh

Weight: 14 pounds

Collapsed size (if applicable): Non-collapsing (rigid)

Any trap that has similar specifications may be considered a BMP trap regardless of brand or source of modification, although performance information on all other BMP criteria (see “Criteria for Evaluation of Trapping Devices”: Introduction pages 4-6) needs to be considered as well. The trap tested was the Tomahawk™ Cage Trap, No 108.5 (Figure RA43).

Additional Information

- Selectivity features: Limited opening size and length restricts large animals; Can be set in shallow water to improve selectivity.
- Special considerations for practicality: Versatile set options (baited sets; blind sets only with double doors); can be used for multiple furbearer species in same sets; large and easily seen (difficult to conceal completely); bulky—requires space for transport and storage (though folding models are available); easy to operate—requires little training; can be used to transport captured animals; captured animals are easily released; continues to operate in freezing weather conditions.



Figure RA46.

Average Mechanical Description and Attributes

Cage material: Solid plastic
 Cage size (length x width x height): 32 x 12 x 12 inches
 Door size (width x height): 12 x 12
 Door material: Solid metal
 Weight: 6 pounds
 Collapsed size (if applicable): Non-collapsing (rigid)

Any trap that has similar specifications may be considered a BMP trap regardless of brand or source of modification, although performance information on all other BMP criteria (see "Criteria for Evaluation of Trapping Devices": Introduction pages 4-6) needs to be considered as well. The trap tested was the Ramconct™ Dura-Poly Box Trap 1232 (Figure RA46).

Additional Information

- Selectivity features: Limited opening size and length restricts large animals; Can be set in shallow water to improve selectivity.
- Special considerations for practicality: Versatile set options (baited sets; blind sets only with double doors); can be used for multiple furbearer species in same sets; large and easily seen (difficult to conceal completely); bulky—requires space for transport and storage (though folding models are available); easy to operate—requires little training; can be used to transport captured animals; captured animals are easily released; continues to operate in freezing weather conditions.



Powered Cable Devices (foot capture) (Figures RA47a & RA47b)

Average Mechanical Description and Attributes

Inside cable retention frame spread (at dog): 6 ³/₈ inches
 Inner width: 5 ³/₄ inches
 Width at jaw hinge posts: 6 inches
 Cable retention frame width: ¹/₈ inch, smooth round rod
 Cable retention frame thickness: ¹/₈ inch rod
 Main trap springs: Two 0.188 inch diameter rod quick-release springs
 Cable diameter: ¹/₈ inch cable
 Base plate: Not reinforced
 Snare loop stop size: 2 inch

Any cable device that has similar specifications may be considered a BMP device regardless of brand or source of modification, although performance information on all other BMP criteria (see "Criteria for Evaluation of Trapping Devices": Introduction pages 4-6) needs to be considered as well. The trap tested was the Belisle™ Foot Snare No.6 (Figures RA47a and RA47b).

Additional Information

- Cable attachment on device tested: Swivel and shock spring with a cable anchor.
- Selectivity features: Pan tension machine screw; large diameter cable and available plastic sleeve often prevents the cable from closing to a small diameter, thus allowing small animals to escape.
- Special considerations for practicality: Some damage and kinking of cable should be expected and will require frequent replacement as a normal part of trap maintenance and upkeep. This device also meets BMP criteria for Eastern & Western coyotes, Canada lynx, Bobcat, Gray fox, and Red fox.

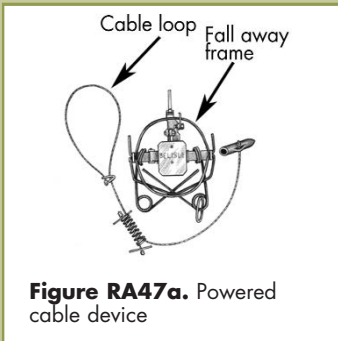

Figure RA47a. Powered cable device



Figure RA47b. Powered cable device (set)

Non-Powered Cable Devices (live restraint; neck) (Figures RA48 and RA49)

Average Mechanical Description and Attributes

Cable diameter: $\frac{3}{32}$ inch, 7 x 7 stranded cable

Cable length: 32 inches

Cable loop stop size: 2 $\frac{1}{2}$ inches

Cable lock: Relaxing lock

Catch loop size: 6 inches

Stop button: $\frac{3}{32}$ inch ferrule

Any cable device that has similar specifications may be considered a BMP device regardless of brand or source of modification, although performance information on all other BMP criteria (see "Criteria for Evaluation of Trapping Devices": Introduction pages 4-6) needs to be considered as well. Relaxing lock used was a non-toothed cam lock (Figure RA48).

Additional Information

- The bottom of the cable restraint catch loop should be ≤ 6 inches from the surface directly below the set.
- Special considerations for selectivity: Break-away devices allow escape with sufficient force; the minimum loop prevents the restraint from closing around an animal's foot. Break away amounts may vary based on regional needs where the potential capture of protected mammals and/or livestock exists.*
- Special considerations for practicality: Some damage and kinking of cable should be expected and will require frequent replacement as a normal part of maintenance.



Average Mechanical Description and Attributes

Cable diameter: $\frac{5}{64}$ inch, 1 x 19 stranded cable

Cable length: 32 inches

Cable loop stop size: 2 $\frac{1}{2}$ inches

Cable lock: Relaxing lock

Catch loop size: 6 inches

Stop button: $\frac{5}{64}$ inch ferrule

Any cable device that has similar specifications may be considered a BMP device regardless of brand or source of modification, although performance information on all other BMP criteria (see "Criteria for Evaluation of Trapping Devices": Introduction pages 4-6) needs to be considered as well. Relaxing lock used was the Slim lock (Figure RA49)

Additional Information

- The bottom of the cable restraint catch loop should be ≤ 6 inches from the surface directly below the set.
- Special considerations for selectivity: Break-away devices allow escape with sufficient force; the minimum loop prevents the restraint from closing around an animal's foot. Break away amounts may vary based on regional needs where the potential capture of protected mammals and/or livestock exists.*
- Special considerations for practicality: Some damage and kinking of cable should be expected and will require frequent replacement as a normal part of maintenance.

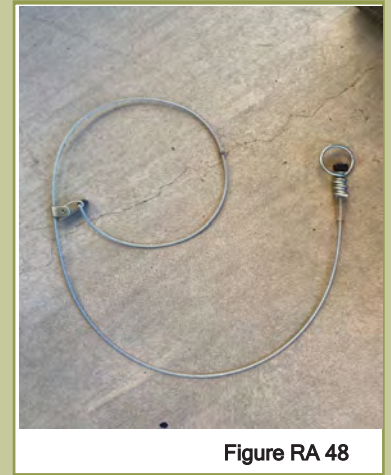

Figure RA 48



Figure RA 49

